

Varenummer: 0102110  
 Beskrivelse: Seeger låsering J 125 DIN 472  
 Fjederstål

## Mål

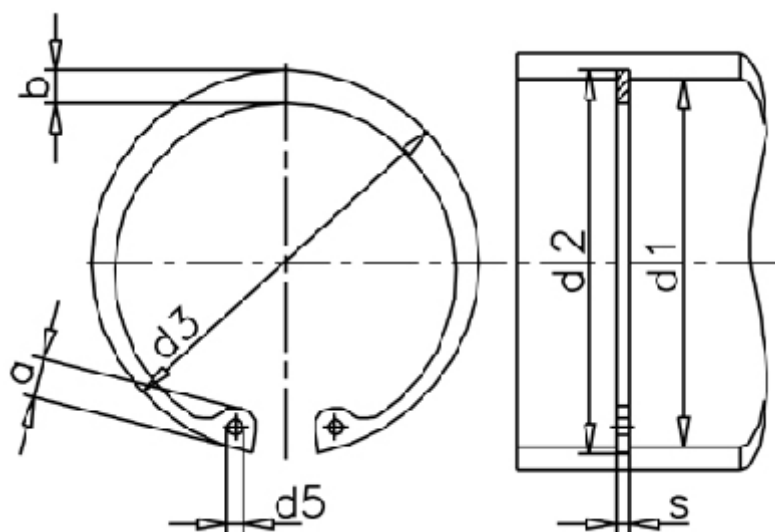

a max	= 11,0	FN kN	= 132.00	t	= 2.00
AN mm <sup>2</sup>	= 797.0	FRg kN	= 70.0	Tang	= ZGJ-4
b	= 10.0	FR kN	= 385.0	tol	= -0.10
Betegnelse	= J 125	g	= 3.0	tol	= +1,50-0,63
d1	= 125	K kN-mm	= 809.0	tol	= +0,63
d2	= 129.0	m min	= 4.15	vægt kg/1000	= 79.00
d3	= 132.00	Nominel træk	= 6.0		
d5 min	= 4.0	s	= 4.00		